



GEOSYSTEMS



GOWEB®

TREE ROOT PROTECTION (TRP) SYSTEM

Powered by GEOSYSTEMS® technology.

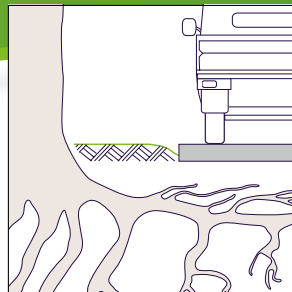

defining **green** in cellular confinement

Greenfix™

SOIL STABILISATION AND EROSION CONTROL LTD

THE PROBLEM

CONSTRUCTION-RELATED TREE DAMAGE

Critical Root Zone/Tree Protection Zone is the minimum area beneath a tree that must remain undisturbed to preserve a sufficient amount of root mass in order to give a tree a chance of survival.

When construction equipment and vehicles intrude a tree's Critical Root Zone, they can cause negative impacts to the soil environment including compaction of the soil, damage to near-surface roots and ultimately endanger the structural integrity of the tree. The majority of a tree's root system is contained within the top three feet of the surface, and construction excavation and compaction can damage or even destroy roots to the point where trees may not survive.

Tree Root Protection (TRP) systems should be eco-friendly as well as comply with local standards and regulations.*

*Compliance with Standards:

In the United Kingdom, Tree Root Protection systems must comply with the Arboricultural Method Statement as outlined in BS5837:2012 and may require supervision by an Arboriculturist.



COMPACTION DAMAGE

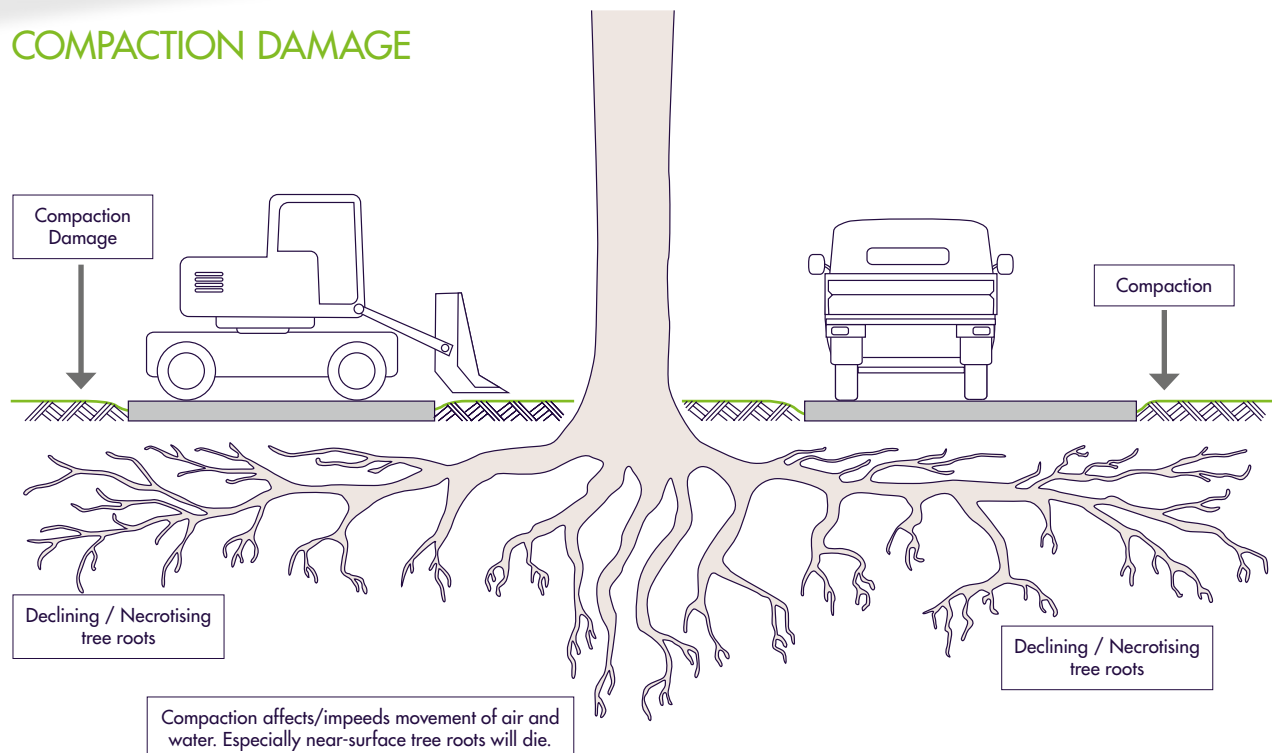

THE GEOWEB® SOLUTION

TREE ROOT PROTECTION (TRP) SYSTEM



Used extensively in civil engineering construction for over 30 years, the GEOWEB® system is a three-dimensional structure that:

- provides strength to confined soils
- distributes loads laterally, not vertically
- reduces point loads
- reduces compaction of the subsoil

Manufactured from high quality, high-strength polyethylene with a textured surface and perforated walls, GEOWEB® cells with selected infill control shearing, lateral and vertical movement, and reduce subbase depth requirements.

The GEOWEB® system is a low impact development (LID) solution with exceptional load-bearing capabilities and environmental benefits. The system has a long history of solving heavy load support problems for roadways, road base support, parking lots, road shoulders, ports, trucking/intermodal terminals and railroads.

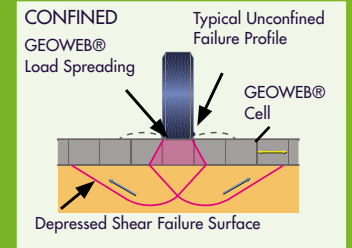
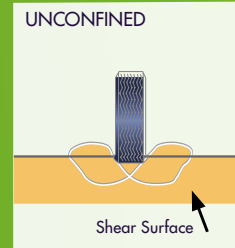

LOAD DISTRIBUTION

By distributing and bridging applied loads, the GEOWEB® TRP system reduces vertical stresses that are typically applied to the underlying soil and root zone.

The GEOWEB® system is ideally suited for tree root protection applications where weak subsoil or no-dig restrictions exist.

COST BENEFITS

The GEOWEB® TRP system is an economical solution for reducing construction vehicle impact to the tree root zone compared with other methods. Once installed, the system has minimal-to-no visibility.

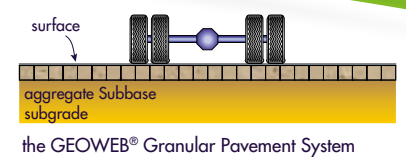
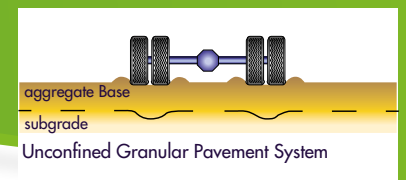

ENVIRONMENTAL BENEFITS

With permeable infill (topsoil/vegetation, aggregate, sand), perforated GEOWEB® cell walls offer environmental benefits:

- water infiltration
- lateral movement of air and water
- water and nutrient migration
- promotes root development

The tree root protection system can be a temporary or permanent solution.

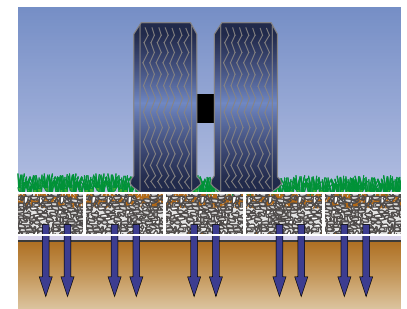

GEOWEB®

TRP SYSTEM INSTALLATION

Step 1: Remove the upper grass and soft soils by hand or by machine if acceptable.

Step 2: Install a high-strength woven geotextile allowing adequate drainage as a separation layer between soft subgrade and GEOWEB® infill material.

Step 3: Expand GEOWEB® sections over the area to be protected and use temporary stakes or weights to hold sections open to prevent movement during infilling.

Step 4: Connect adjacent sections using ATRA® Keys. Position the sections so the slots are aligned, insert the key and turn 90 degrees locking the panels together. ATRA® Keys provide a long-term connection that is safer, quicker and stronger than staples or cable ties. In environmentally protected areas (SSSI in United Kingdom), ATRA® Keys can be used without the requirement for diesel-fueled compressors.

Step 5: For permeability, infill the fully connected GEOWEB® system with a well graded, crushed, angular stone such as MOT Type 1X (also known as MOT Type3). Over fill the cells by up to 30mm to allow for compaction.

Step 6: Compact the fill material with conventional plant or non-vibratory plant when required. Fill should be maintained above the GEOWEB® system by a minimum of 10mm at all times or a permanent wearing course of blocks, porous asphalt or gravel installed.



DESIGN CONSIDERATIONS

It is important to ensure the correct GEOWEB® cell size and cell depth are specified and installed based on the anticipated pavement loads. These are calculated based on the following criteria:

- traffic type and loading
- frequency of traffic
- subgrade strength (typically CBR, Ev2, Cu or SPT values)
- infill type
- allowable settlement of the pavement

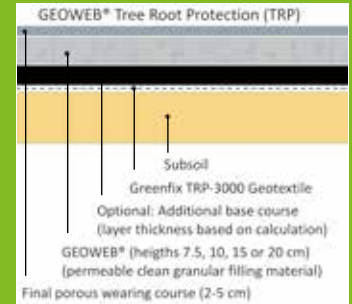

To assist you in determining the correct GEOWEB® solution for your application, Presto GEOSYSTEMS® or their network of distributors/representatives can assist with the calculation for your project. You can be confident that you will receive the most suitable and economical solution for your project.

PRESTO GEOSYSTEMS® COMMITMENT — To provide the highest quality products and solutions.

Presto GEOSYSTEMS® is committed to helping you apply the best solutions for your tree root protection needs. Our solutions-focused approach to solving problems adds value to every project. Rely on the leaders in the industry when you need a solution that is right for your application. Contact Presto GEOSYSTEMS® or our worldwide network of knowledgeable distributors/representatives for assistance.



PRESTO GEOSYSTEMS®
Appleton, Wisconsin, USA

EUROPEAN HEAD OFFICE:



SOILTEC GmbH:
Neue Finien 7a
28832 Achim | Germany

Tel.: 04202-7670-0
Fax: 04202-7670-50

E-Mail: geosystems@soiltec.de
www.soiltec-geosystems.de

DISTRIBUTED BY:

GREENFIX SOIL STABILISATION AND EROSION CONTROL LIMITED

NORTHERN OFFICE

Pennine House
Hurricane Court
Concorde Way
Stockton on Tees
TS18 3TL

Tel.: 01642 633519
Fax: 01642 618525

E-Mail: russ@greenfix.co.uk

SOUTHERN OFFICE

Willington
Shipston-On-Stour
Warwickshire
CV36 5AS

Tel.: 01608 664753
Fax: 01608 665468

E-Mail: daniel@greenfix.co.uk

PRESTO



INSTALLATION GUIDE

■ **simplified**



GEOWEB® Tree Root Protection





GEOWEB® Tree Root Protection

- 1 Prepare subgrade. Remove debris, rocks.



- 2 Install TRP4000 geotextile. Overlaps by minimum 300 mm.

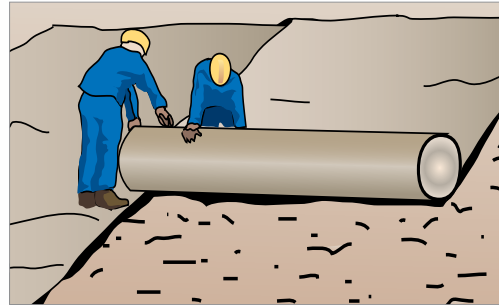

- 3 Partially expand GEOWEB® sections.

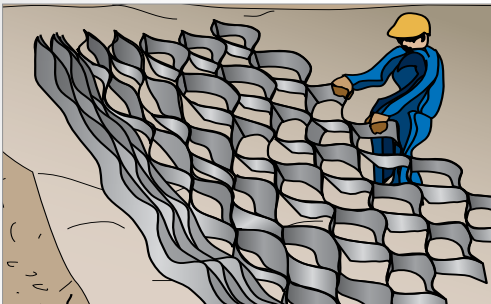

- 4 Connect GEOWEB® sections with ATRA® keys.

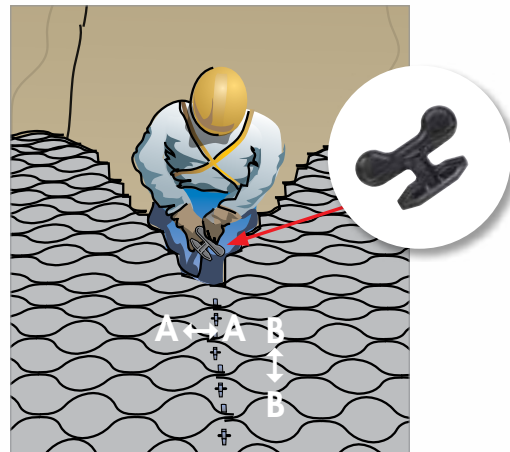

- 5 Connect side to side (A) and end to end (B).

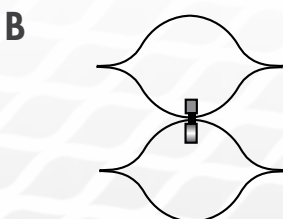
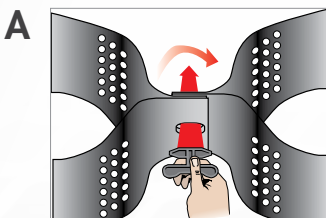

- 6 Fully expand GEOWEB® sections.

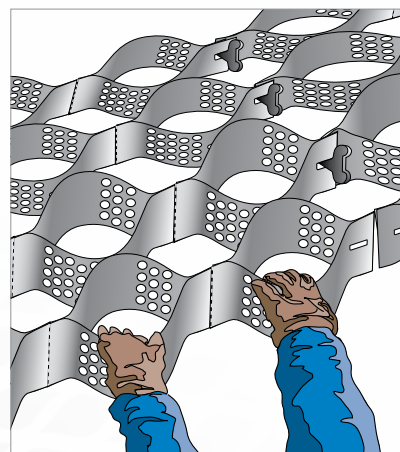

IMPORTANT NOTE:

The simplified installation guide provided by Presto GEOSYSTEMS® is intended as a general guideline only. The contractor should follow contract plans and specifications and refer to detailed installation guidelines for more information.

7 Hold sections open. Use Options A, B, C or D.

A T-Bars



B ATRA® anchors

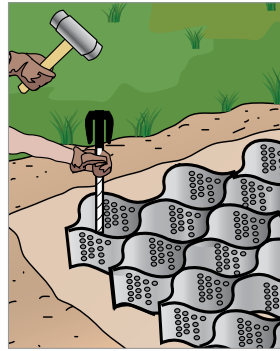

C Wood Stakes



D Infill Select Cells



8 Infill GEOWEB® cells.

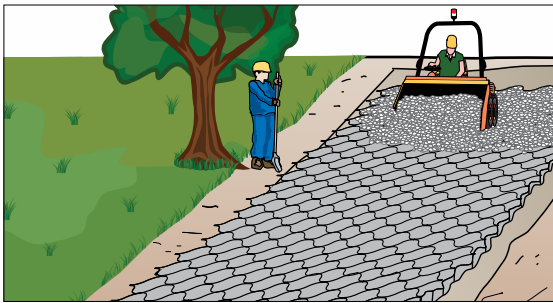

9 Spread Infill ensuring a 25 mm overfill at all times.



10 If required, use a 4t smooth, non-vibrating roller on overfilled GEOWEB® system. Refill as needed to ensure a 25 mm overfill.

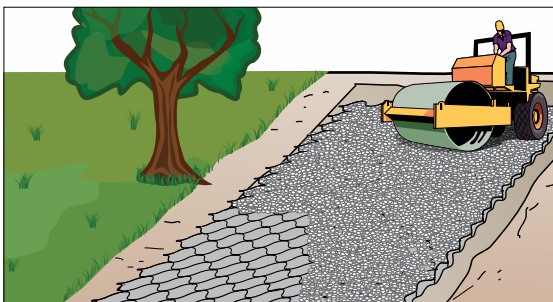

11 Surface option ready to install according to specification.

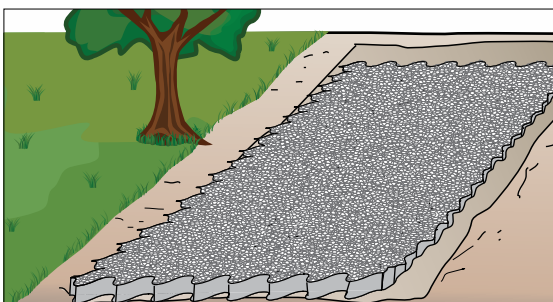

Greenfix
Soil Stabilisation and Erosion Control Specialists

info@greenfix.co.uk
tel: 01608 666027
www.greenfix.co.uk

Geoweb infill material for Tree Root Protection
Clean Angular Stone 4-20mm

Specification for open graded infill material for Geoweb cellular confinement within tree root protection applications. The no fines material is to ensure high ratio void space which corresponds with ideal soil void ratios for tree root health.

Material to BS EN 13242 or BS EN 12620. Crushed gravel is not permitted.

Properties of material	Test	Value
Grading of particle size	BS EN 13242	Grading 4-20mm
Fines Content	BS EN 13242	f ₀
Shape flatness index	BS EN 13242	F ₁₀
Resistance to fragmentation	BS EN 13242	LA ₁₀
Resistance to wear	BS EN 13242	M ₁₀ 20
Water absorption rate BS EN 1097-6:2000 clause 7	BS EN 13242	WA ₂ 2
For typical WA>2% magnesium sulphate soundness	BS EN 13242	MS ₁₈
Acid soluble sulphate content air-cooled blast furnace slag	BS EN 13242	AS _{0.1}
Acid soluble sulphate content non air cooled blast furnace slag	BS EN 13242	AS _{0.2}
Total sulphur aggregates other than air cooled blast furnace slag	BS EN 13242	<1% by mass
Total sulphur air cooled blast furnace slag	BS EN 13242	<2% by mass

Sieve Size mm	Percentage of 4-20mm passing
40	100
31.5	98 - 100
20	90 - 99
10	25 - 70
4	0 - 15
2	0 - 5
1	-

Air cooled blast furnace and steel slag should be free from Dicalcium silicate and iron disintegration in accordance with BS EN 13242:2002, 6.4.2.2 VS
Leaching of materials for blast furnace slag and other recycled materials should meet requirements of the Environmental waste acceptance criteria for inert waste when tested in accordance with BS 12457-3
On poor site conditions which require compaction, this should be minimum 4 passes of a smooth wheeled roller at max weight 1000kg/m width without vibration.

For assistance on correct 4–20mm clean angular stone infill specification, please contact Greenfix technical team.



GEOSYSTEMS®

MATERIALS SUPPLIED BY **Greenfix**

GEOWEB®



TRP4000
Non-woven Geotextile



ANCHORS ATRA® KEY



ADDITIONAL MATERIALS REQUIRED

4–20mm clean, angular stone



LIMITED WARRANTY

Presto GEOSYSTEMS® warrants each GEOWEB® section which it ships to be free from defects in materials and workmanship at the time of manufacture. Presto's exclusive liability under this warranty or otherwise will be to furnish without charge to Presto's customer at the original f.o.b. point a replacement for any section which proves to be defective under normal use and service during the 10-year period which begins on the date of shipment by Presto. Presto reserves the right to inspect any allegedly defective section in order to verify the defect and ascertain its cause.

This warranty does not cover defects attributable to causes or occurrences beyond Presto's control and unrelated to the manufacturing process, including, but not limited to, abuse, misuse, mishandling, neglect, improper storage, improper installation, improper alteration or improper application.

PRESTO MAKES NO OTHER WARRANTIES, EXPRESS OR IMPLIED, WRITTEN OR ORAL, INCLUDING, BUT NOT LIMITED TO, ANY WARRANTIES OR MERCHANTABILITY OR FITNESS FOR ANY PARTICULAR PURPOSE, IN CONNECTION WITH THE GEOWEB® SYSTEM. IN NO EVENT SHALL PRESTO BE LIABLE FOR ANY SPECIAL, INDIRECT, INCIDENTAL OR CONSEQUENTIAL DAMAGES FOR THE BREACH OF ANY EXPRESS OR IMPLIED WARRANTY OR FOR ANY OTHER REASON, INCLUDING NEGLIGENCE, IN CONNECTION WITH THE GEOWEB® SYSTEM.

GEOSYSTEMS®, GEOWEB®, and ATRA® are registered trademarks of Reynolds Presto Products Inc.

GEOWEB® MANUFACTURER:



PRESTO GEOSYSTEMS®
Appleton, Wisconsin, USA

EU HEAD OFFICE/ENGINEERING SUPPORT:



SOILTEC GmbH: Germany
www.soiltec-geosystems.de

DISTRIBUTED BY:



Greenfix Soil Stabilisation & Erosion Control Limited
Old Manor Farm Yard
Beckford Road
Ashton under Hill
Evesham
Worcestershire
WR11 7SU
info@greenfix.co.uk
www.greenfix.co.uk
01608666027

Geoweb Weight Distribution Guidance

This document is for reference on generic site conditions of CBR 3% and for guidance only. For tree root protection, site specific solutions are always recommended. For an engineered calculation, relevant to both CBR and soil bulk density, please contact Greenfix who will provide assistance and a full technical recommendation.

Geoweb Depth	Weight	Application
GW20V3 75mm Geoweb	1t Gross Weight	Ideal for pedestrian foot traffic and cycle paths.
GW20V4 100mm Geoweb	6t Gross Weight	For light vehicle traffic applications, such as cars and transit vans.
GW20V6 150mm Geoweb	30t Gross Weight	For increased vehicle weight applications, such as public carparks, refuse collection vehicles and emergency access routes.
GW20V8 200mm Geoweb	60t Gross Weight	For requirement of high level weight distribution, such as H.G.V and construction traffic
GW40V12 300mm Geoweb	-	A control measure to increase ground levels within tree rooting areas, whilst maintaining existing soil bulk densities for tree root health. For information on how Geoweb distributes the weight of its own porous infill, and for site specific recommendations, please contact Greenfix.

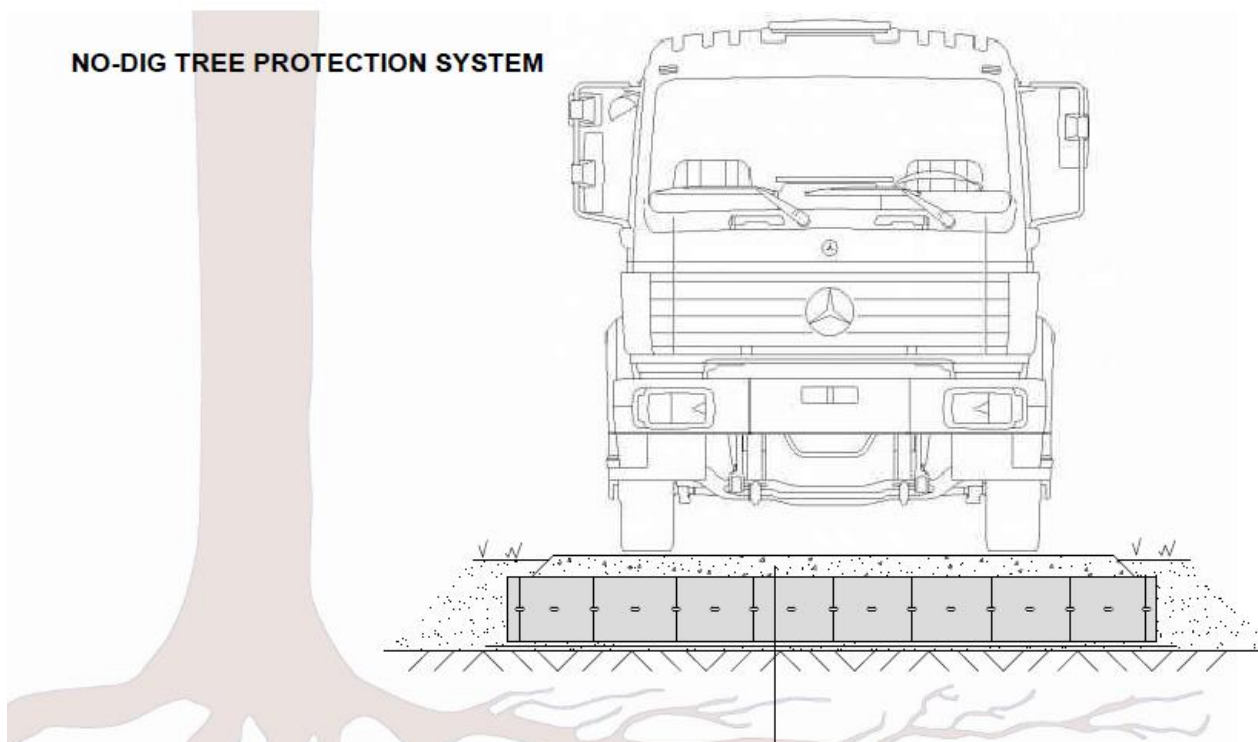

Clean Angular Stone 4-20mm

Infill Material for Geoweb Tree Root Protection

Specification for open graded infill material for Geoweb cellular confinement within tree root protection applications. The no fines material is to ensure high ratio void space which corresponds with ideal soil void ratios for tree root health.

Material to BSEN1342 or BSEN12620. Clean, sound, non-friable, crushed rock with well-defined edges – not round.

Properties of material	Test	Value
Grading of particle size	BSEN 13242	Grading 4-20mm
Fines Content	BSEN 13242	f4
Shape flakiness index	BSEN 13242	FI20
Resistance to fragmentation	BSEN 13242	LA30
Resistance to wear	BSNE 13242	MDE20
Water absorption rate BSNE 1097-6:2000 clause 7	BSNE 13242	WA242
For typical WA > 2% magnesium sulphate soundness	BSNE 13242	MS18
Acid soluble sulphate content air-cooled blast furnace slag	BSNE 13242	AS0.1
Acid soluble sulphate content non air-cooled blast furnace slag	BSNE 13242	AS0.2
Total sulphur aggregates other than air cooled blast furnace slag	BSNE 13242	<1% by mass
Total sulphur air cooled blast furnace slag	BSNE 13242	<2% by mass

Sieve Size mm	Percentage of 4-20mm passing
40	100
31.5	98 - 100
20	90 - 99
10	25 - 70
4	0 - 15
2	0 - 5
1	-



Where decorative gravel is being used as the final surface wearing layer it is very important to ensure angular stone is used within the cells. The angular stone should be filled just above the top of the cell wall and compacted with a smooth wheeled roller of max weight 1000kg/m width without vibration for a minimum of 4 passes. The stone should lock together to form a solid base. We recommend a small test area before using if there is any doubt. Decorative gravel can be placed over the fill material, we recommend no more than 50mm.

MOT type3 is also an option for fill material for certain applications (consult your Arboriculturist). This is a graded stone with limited fines and will achieve a compact base. Voids are more than 25% after compaction and it is recommended for areas which require SUDS compliance.



GW30V / G3V3 - 75 mm (3 in) Depth

GEOWEB® SYSTEM PERFORMANCE & MATERIAL SPECIFICATION SUMMARY

	Property	Value				Test Method	
Base Material	Material Composition	Polymer – Polyethylene with density of 0.935 – 0.965 g/cm ³ (58.4 - 60.2 lb/ft ³)				ASTM D 1505	
	Color	Black - from Carbon Black	Tan, Green, Other Colors with no heavy metal content		N/A		
	Stabilizer	Carbon black content 1.5% - 2% by weight	Hindered amine light stabilizer (HALS) 1.0% by weight of carrier		N/A		
	Minimum ESCR	3000 hr				ASTM D 1693	
Strip Properties	Sheet Thickness	1.27 mm -5% +10% (50 mil -5% +10%)				ASTM D 5199	
	Surface Treatment	Performance: The polyethylene strips shall be textured and perforated such that the peak friction angle between the surface of the textured / perforated plastic and a #40 silica sand at 100% relative density shall be no less than 85% of the peak friction angle of the silica sand in isolation when tested by the direct shear method per ASTM D 5321. The quantity of perforations shall remove 13.85% ± 0.5% of the cell wall area.		Material: The polyethylene strips shall be textured with a multitude of rhomboidal (diamond shape) indentations. The rhomboidal indentations shall have a surface density of 22 – 31 per cm ² (140 – 200 per in ²). In addition, the strips shall be perforated with horizontal rows of 10 mm (0.4 in) diameter holes. Perforations within each row shall be 19 mm (0.75 in) on-center. Horizontal rows shall be staggered and separated 12 mm (0.50 in) relative to the hole centers. The edge of strip to the nearest edge of perforation shall be 8 mm (0.3 in) minimum and the centerline of the weld to the nearest edge of perforation shall be 18 mm (0.7 in) minimum. A slot with a dimension of 10 mm x 35 mm (3/8 in x 1 3/8 in) is standard in the center of the non-perforated areas and at the center of each weld.			
Cell & Seam Properties	Cell Details	Depth	Nominal Dimensions ±10%		Density per m² (yd²)	Nominal Area ±1%	Perforations / Cell
			Length	Width			
	GW30V / G3V3	75 mm (3 in)	287 mm (11.3 in)	320 mm (12.6 in)	21.7 (18.2)	460 cm ² (71.3 in ²)	
	Short-term Seam Peel Strength	Cell Depth		Minimum Certified Cell Seam Strength			
	75 mm (3 in)		1060 N (240 lbf)				
Long-term Seam Peel Strength	Long-term seam peel-strength test shall be performed on all resin or pre-manufactured sheet or strips. A 100 mm (4.0 in) wide seam sample shall support a 72.5 kg (160 lb) load for a period of 168 hours (7 days) minimum in a temperature-controlled environment undergoing a temperature change on a 1-hour cycle from ambient room to 54°C (130°F). Ambient room temperature is per ASTM E 41.						
Section Properties	Section Dimension	Section Width	Section Length Range (Cells Long: 18, 21, 25, 29, 34)				
		Variable	Minimum		Maximum		
GW30V / G3V3	2.3 m (7.7 ft) to 2.8 m (9.2 ft)	4.7 m (15.4 ft)		10.7 m (35.1ft)			
Certifications & Warranties	Geoweb® Material	Geoweb® sections are manufactured under a quality management system that is ISO-9001:2000 certified. For additional certification and warranty information, refer to the Presto Geosystems Geoweb® Cellular Confinement System Material Specification .					

